

FRONT

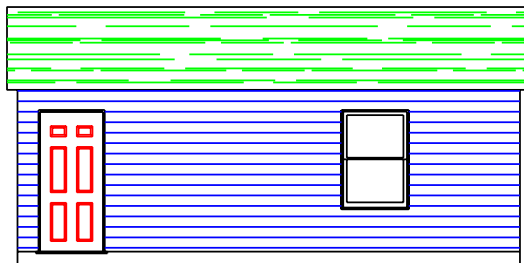

RIGHT SIDE

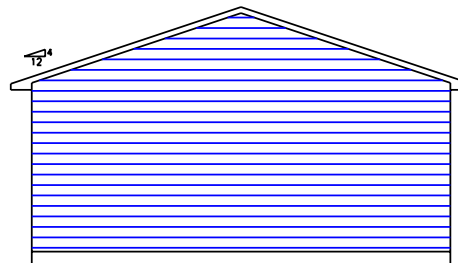

BACK

INDEX	#
ELEVATION	COVER
FLOOR LAYOUT	1
FOUNDATIONS:	
CONCRETE SLAB	2A
WOOD/PEIRS	2B
FLOOR PLAN	3
FLOOR FRAMING	4
ROOF FRAMING	5
ELECTRICAL	6
ELECTRICAL CONT.	6A
DETAILS:	
CROSS SECTION	D1
DOOR/WINDOW FRAMING	D2
MATERIAL LIST	

GREENLEAF DESIGNS

7455 GILBERT RD. CASS CITY, MI 48726

PROJECT NAME:
SAMPLE
20x24 LODGE

DRAWING TITLE:
ELEVATION

DRAWING NO.
COVER

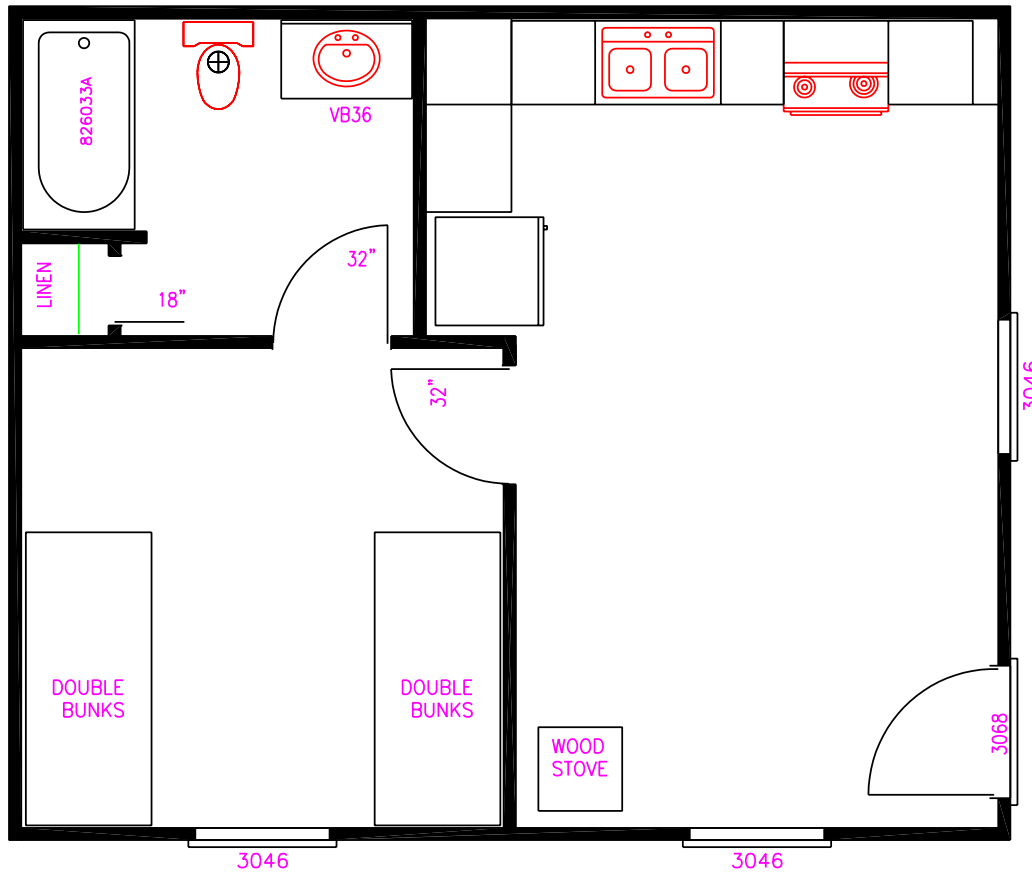

NOTE:
 THIS IS A ARTIST RENDITION,
 THE ACTUAL PLACEMENT OF FURNITURE
 AND KITCHENETTE MAY VARY.

GREENLEAF DESIGNS
 7455 GILBERT RD. CASS CITY, MI 48726

PROJECT NAME:
 SAMPLE
 20x24 LODGE

DRAWING TITLE:
 FLOOR LAYOUT

DRAWING NO.
 1

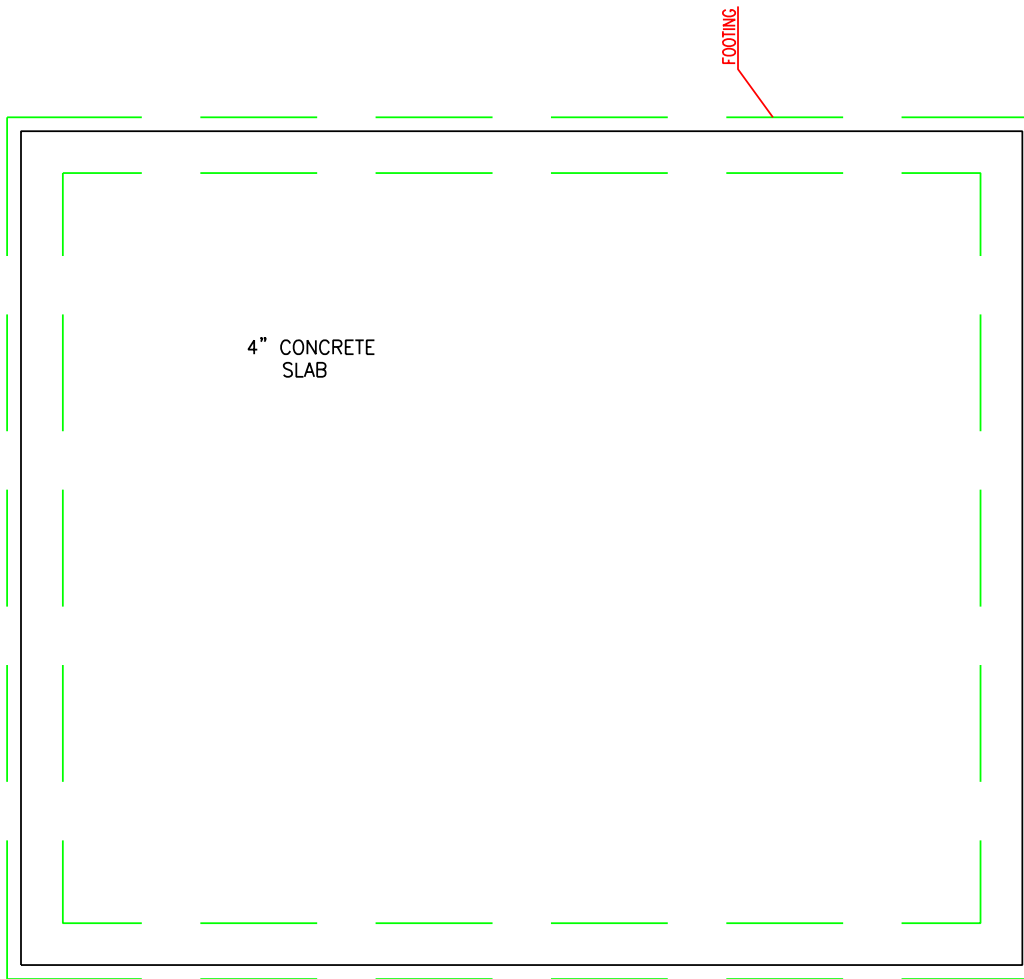

GENERAL NOTES:

ALL FOOTINGS MUST BE ON SAFE UNDISTURBED EARTH AND BELOW THE FROSTLINE.

FINISH GRADE DRAINAGE SWALES AROUND AND AWAY FROM BUILDING PERIMETER TO MIN. 5% GRADIENT 1/2" PER FOOT.

FOUNDATION CAN BE POURED CONCRETE SLAB, CONCRETE BLOCK.

ALL SILL PLATES MUST BE TREATED LUMBER.

CHECK LOCAL BUILDING CODES FOR PROPER FOOTING WIDTH AND DEPTH. IF REQUIRED.

GREENLEAF DESIGNS

7455 GILBERT RD. CASS CITY, MI 48726

PROJECT NAME:
SAMPLE
20x24 LODGE

DRAWING TITLE:
FOUNDATION
CONCRETE SLAB OPTION

DRAWING NO.
2A

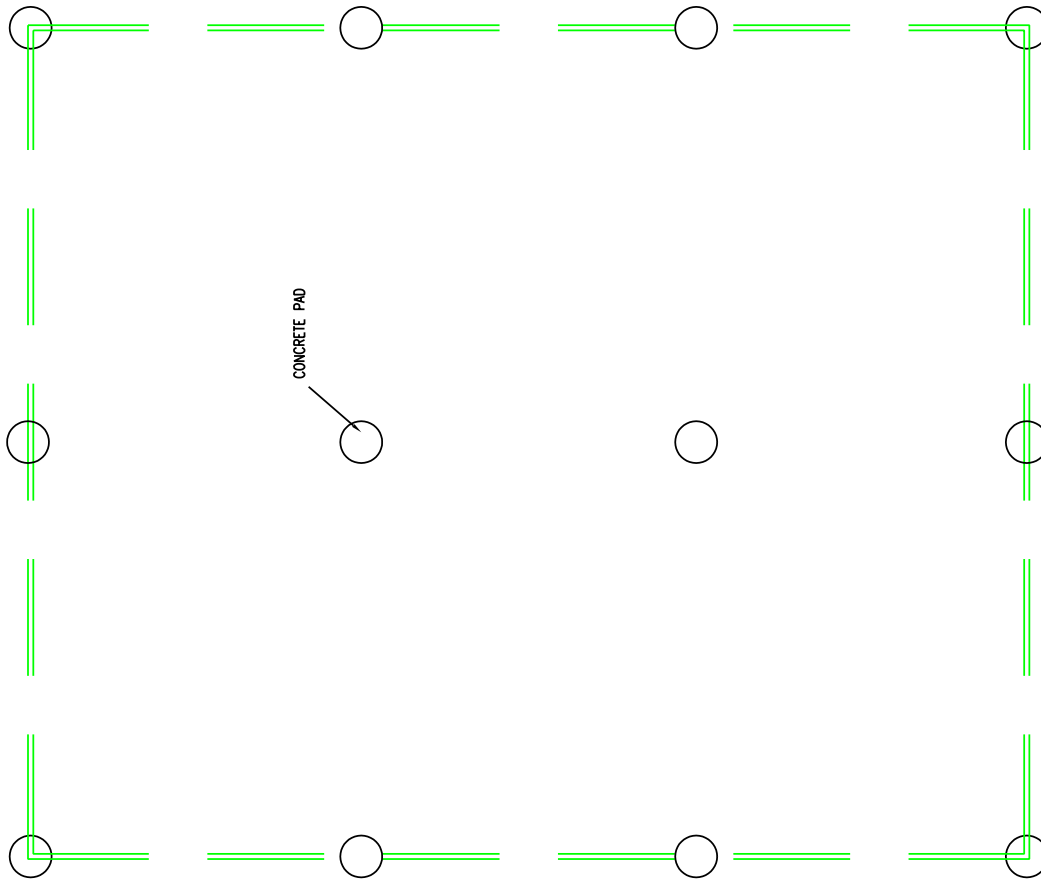

NOTES:
CHECK LOCAL BUILDING CODES
FOR PROPER SIZE AND DEPTH.
IF REQUIRED.

GREENLEAF DESIGNS
7455 GILBERT RD. CASS CITY, MI 48726

PROJECT NAME:
SAMPLE
20x24 LODGE

DRAWING TITLE:
FOUNDATION
WOOD FLOOR OPTION

DRAWING NO.
2B

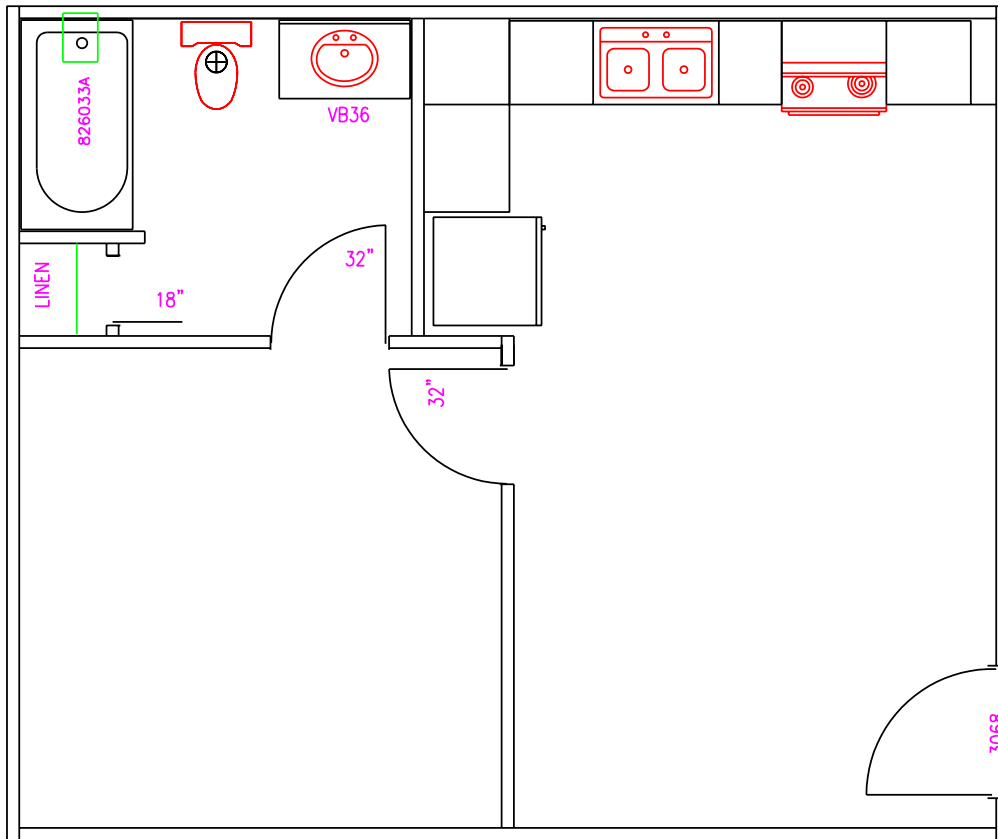

GREENLEAF DESIGNS
 7455 GILBERT RD. CASS CITY, MI 48726

PROJECT NAME:
 SAMPLE
 20x24 LODGE

DRAWING TITLE:
 FLOOR PLAN

DRAWING NO.
 3

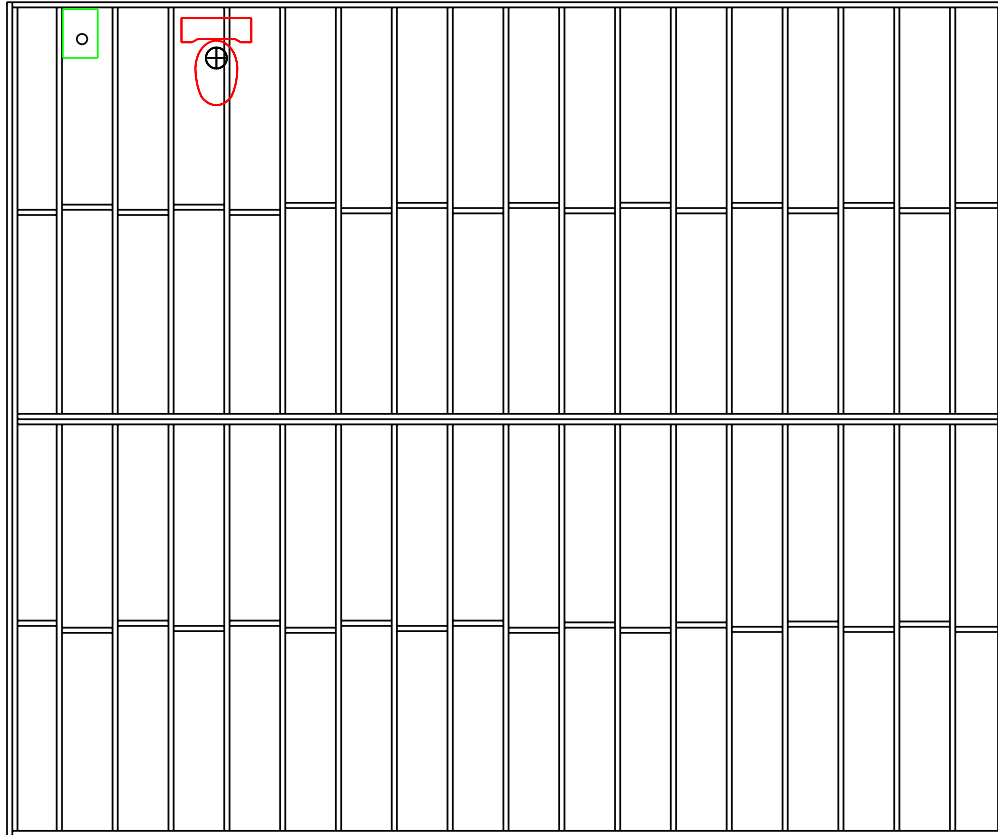

GREENLEAF DESIGNS
7455 GILBERT RD. CASS CITY, MI 48726

PROJECT NAME:
SAMPLE
20x24 LODGE

DRAWING TITLE:
FLOOR FRAMING

DRAWING NO.
4

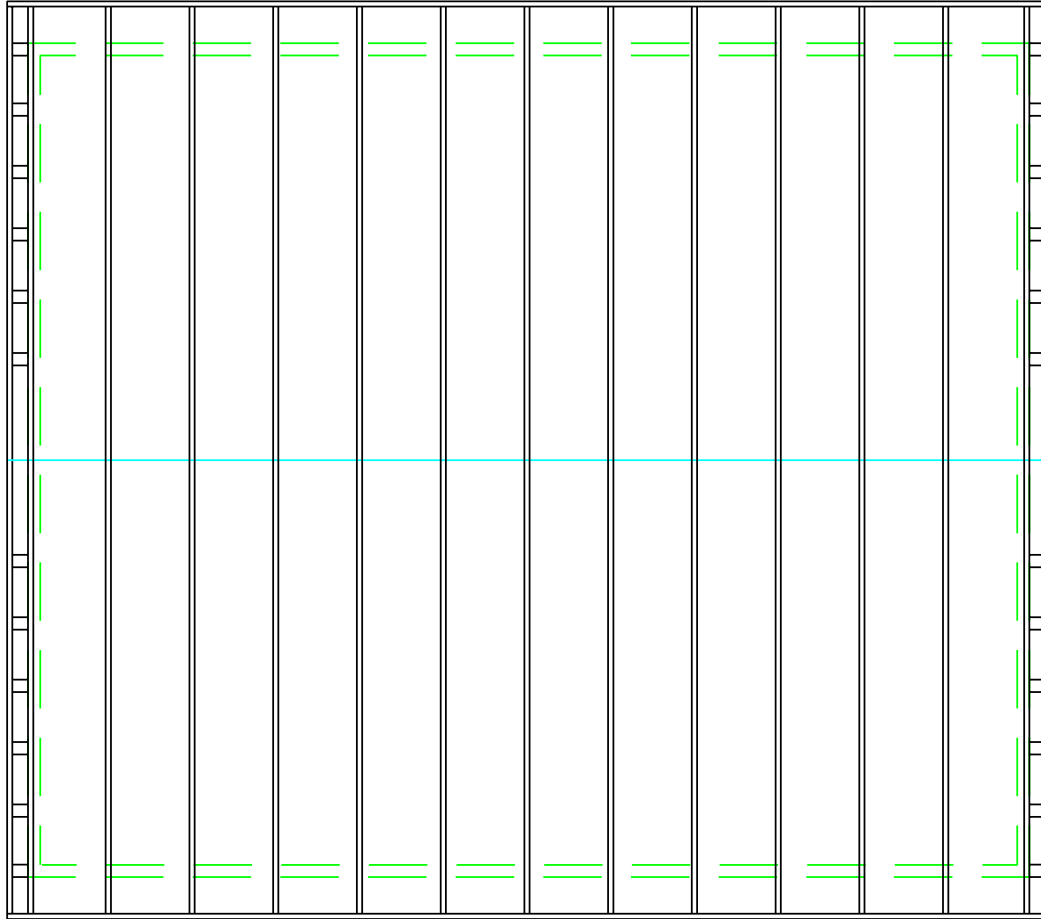

GREENLEAF DESIGNS
7455 GILBERT RD. CASS CITY, MI 48726

PROJECT NAME:
SAMPLE
20x24 LODGE

DRAWING TITLE:
ROOF FRAMING

DRAWING NO.
5

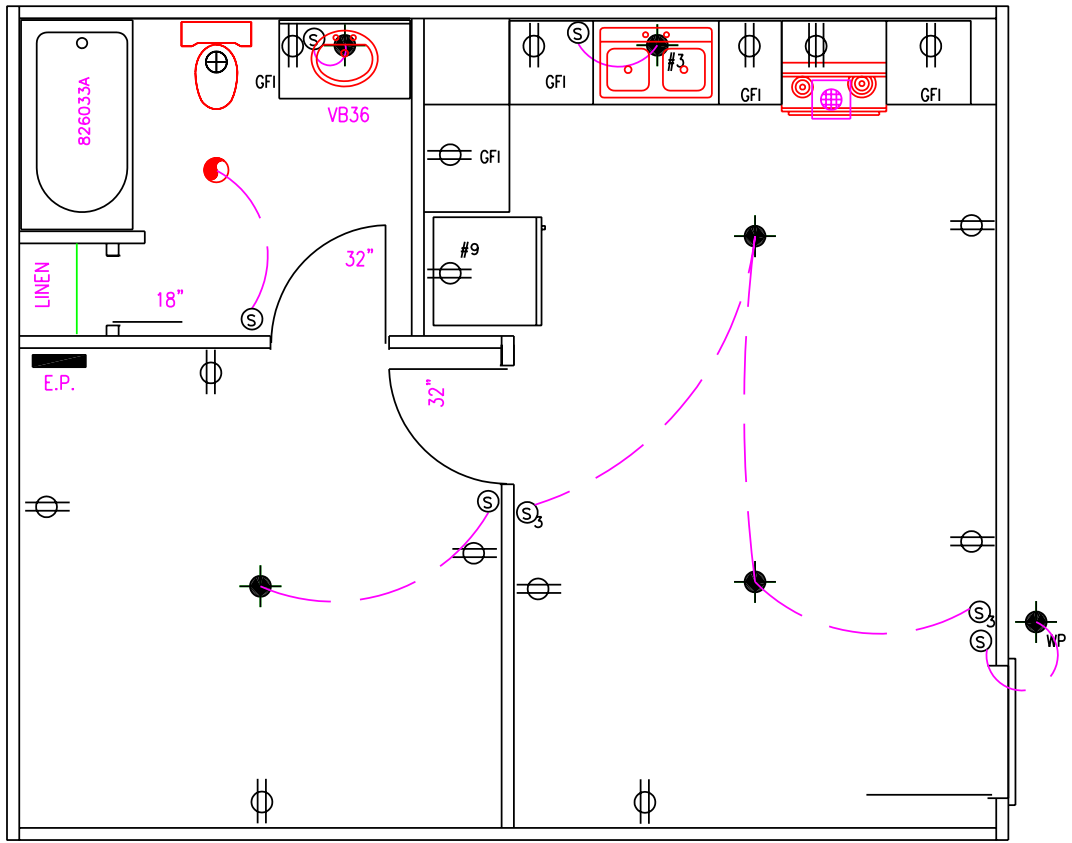











GREENLEAF DESIGNS

7455 GILBERT RD. CASS CITY, MI 48726

PROJECT NAME:
SAMPLE
20x24 LODGE

DRAWING TITLE:
ELECTRICAL

DRAWING NO.
6

	RANGE HOOD
	ELECTRICAL PANEL
	EXHAUST FAN
	WEATHER PROOF RECEPTACLE
	220 RECEPTACLE
	RECEPTACLE
	LIGHT
	LIGHT
	3-WAY SWITCH
	SWITCH

100 AMP ELEC. PANEL

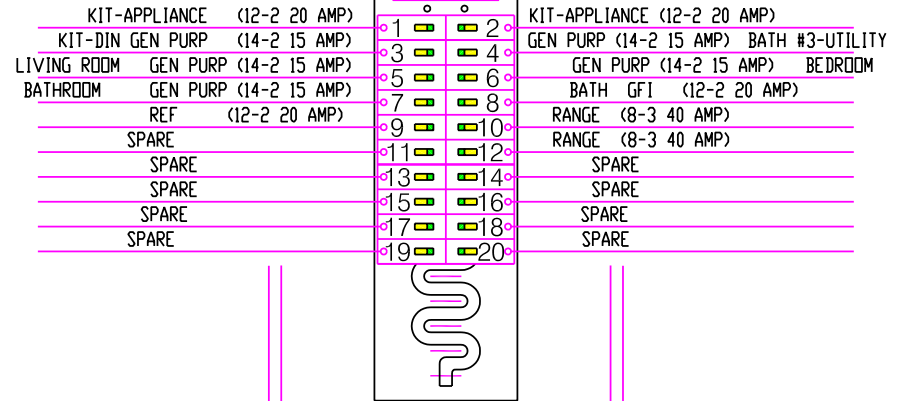

GREENLEAF DESIGNS
7455 GILBERT RD. CASS CITY, MI 48726

PROJECT NAME:
SAMPLE
20x24 LODGE

DRAWING TITLE:
ELECTRICAL

DRAWING NO.
6A

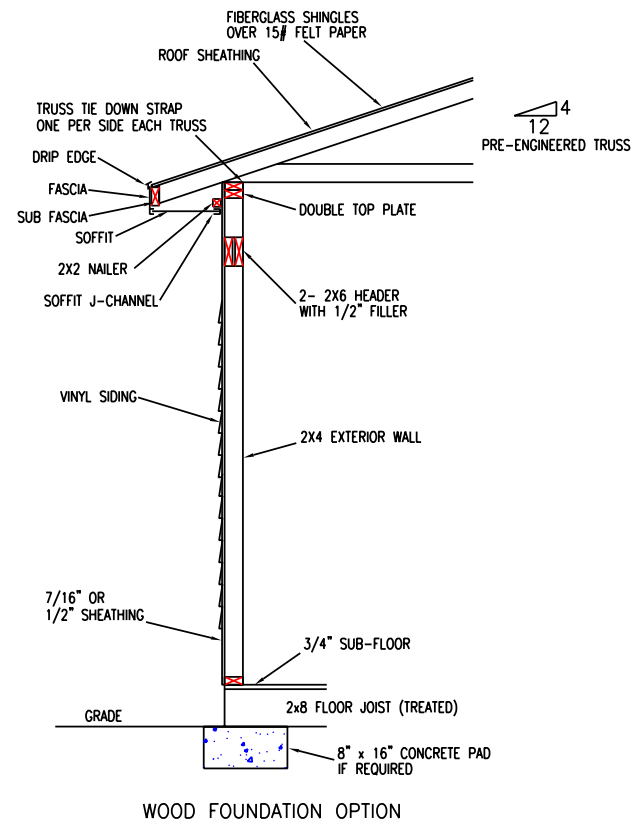
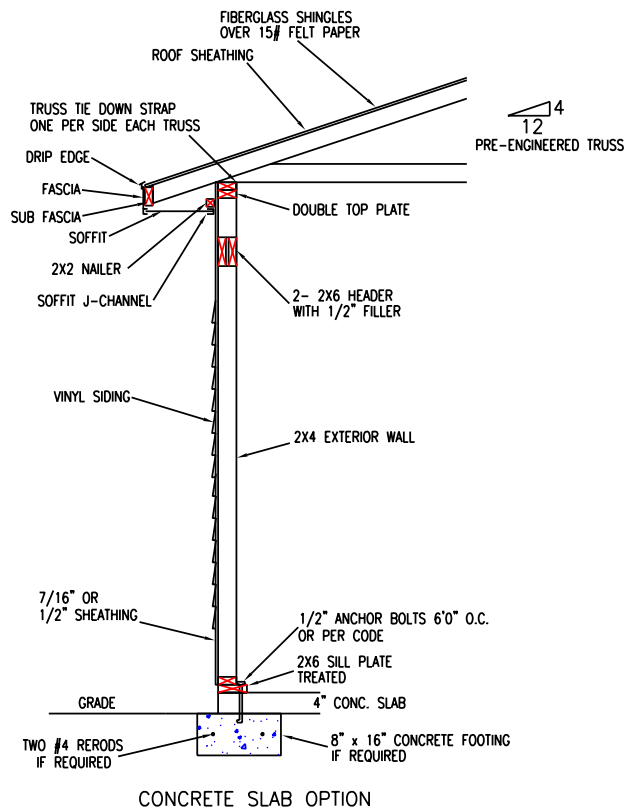

WALL CROSS SECTION

GREENLEAF DESIGNS

7455 GILBERT RD. CASS CITY, MI 48726

PROJECT NAME:
SAMPLE
20x24 LODGE

DRAWING TITLE:
DETAILS
CROSS SECTION

DRAWING NO.
D1

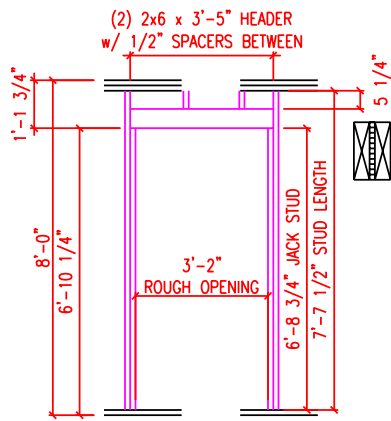

EXTERIOR DOOR
FRAMING

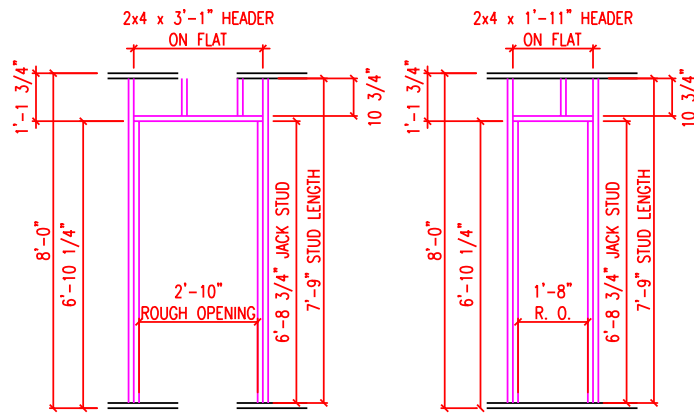

INTERIOR DOOR
FRAMING

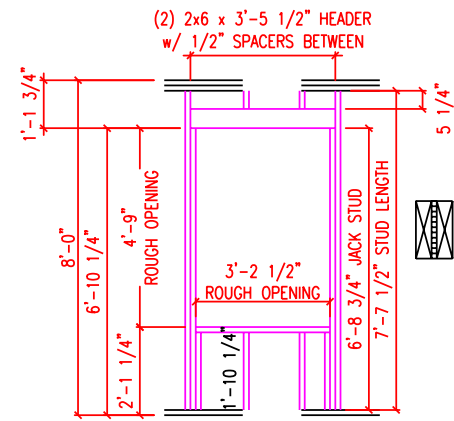

WINDOW
FRAMING

NOTE:
CHECK WITH MANUFACTURER ON PROPER
ROUGH OPENING DIMENSIONS.

GREENLEAF DESIGNS

7455 GILBERT RD. CASS CITY, MI 48726

PROJECT NAME:
SAMPLE
20x24 LODGE

DRAWING TITLE:
DETAILS
DOOR/WINDOW FRAMING

DRAWING NO.
D2A

Tel: 989-872-5224
www.greenleaf-designs.com



7455 Gilbert Rd.
 Cass City, MI 48726

Material List for Hunting Lodge

Material	Quantity
Floor	
Joists - 2x8x12'	Check with Local Supplier For Proper Quantity Amounts
Bridging – 2x8x1'-2 1/2"	
Sub floor – 3/4" 4x8 Plywood	
Joist Hangers	
Walls	
Studs – 2x4x8'	
Top and Bottom Plate – 2x4x12'	
Sheathing – 1/2" 4x8 OSB	
Roof	
Premanufactured Trusses – 12' 4/12 Pitch	
Rakes – 2x4x8'	
Sub fascia – 2x4x12'	
Weather Guard – Roll	
Felt Paper – Roll	
Shingles - Bundles	
Truss Tie-down Straps	
Drip Edge	
Sheathing – 1/2" 4x8 OSB	
Doors	
3'-0" x 6'-8" Exterior Door	
Windows	
3'-0" x 3'-10" Window	
Finishing Materials	
Fascia	
Soffit	
F-channel	
<i>J-channel</i>	
Vinyl Siding	